

ACE Aluminum Tower

Highly Versatile with variable heights and ready to erect

Double width with built in ladder

SWL = 270kg per platform / 850 kg per tower

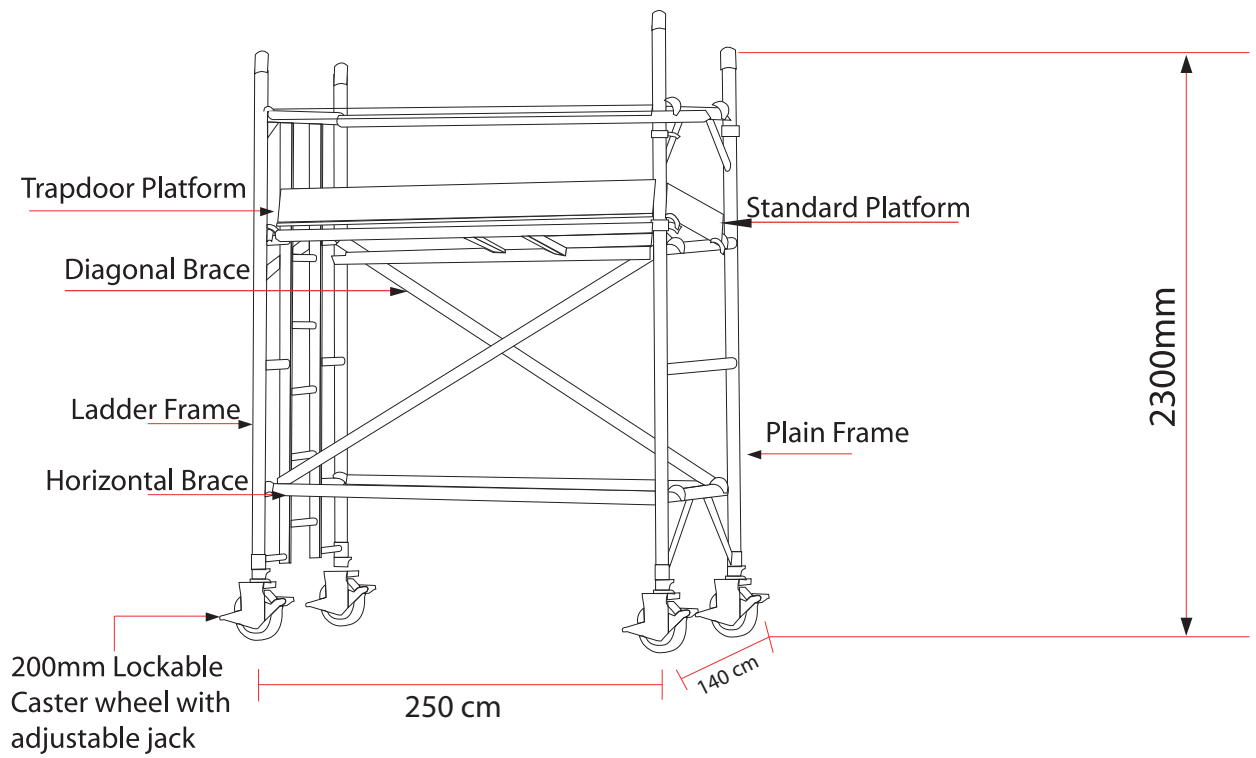

Tower Ref.	DW- 250 x 140/2
Working Height	3.3 m
Tower Height	2.3 m
Platform Height	1.3 m
Width	1.40 m
Length	2.5 m